



At the heart of the image



I AM FULL THROTTLE



85
million
NIKKOR

D4s

www.europe-nikon.com



Sharp, quick AF acquisition to capture even the most unpredictable subjects

With significantly refined autofocus performance, the D4S delivers sharp focus with fast and accurate initial AF detection, even when subjects are thrust unpredictably into the frame.

• Lens: AF-S NIKKOR 70-200mm f/2.8G ED VR II • Image quality: 14-bit RAW (NEF) • Exposure: [M] mode, 1/2000 second, f/4.5 • White balance: Direct sunlight • Sensitivity: ISO 200
• Picture Control: Standard © Robert Beck



Tenacious AF tracking: Extreme motion captured, even at close range

When shooting sports, it can be challenging to get up close to the action, while still retaining the ability to accurately and reliably track your subject. With the D4S, that task is now much easier.

• Lens: AF-S NIKKOR 600mm f/4G ED VR • Image quality: 14-bit RAW (NEF) • Exposure: [M] mode, 1/2000 second, f/4 • White balance: Direct sunlight
• Sensitivity: ISO 320 • Picture Control: Standard © Robert Beck





Sharp and clear regardless of the light, with vastly improved noise reduction

Even in low-lit environments, the D4S produces amazing image quality with accurately reproduced skin tones. Fine details really make your images pop, giving them a lifelike feeling of depth.

• Lens: AF-S NIKKOR 14-24mm f/2.8G ED • Image quality: 14-bit RAW (NEF) • Exposure: [M] mode, 1/500 second, f/4 • White balance: Auto 1 • Sensitivity: ISO 6400 • Picture Control: Standard © Dave Black



Assuring, liberating AF lets you focus more on composition

Photographers can confidently rely on the D4S's autofocus performance, which holds subjects tightly so they can concentrate more on composition. The new group-area AF detects and keeps subjects in focus with five AF points, letting you shoot erratically moving subjects with complete assurance.

• Lens: AF-S NIKKOR 800mm f/5.6E FL ED VR • Image quality: 14-bit RAW (NEF) • Exposure: [M] mode, 1/1600 second, f/7.1 • White balance: Auto 1 • Sensitivity: ISO 1000 • Picture Control: Standard © Dave Black





Versatile autofocus lets you confidently capture the most elusive movements

Wildlife photography requires fast initial AF acquisition and relentless tracking capabilities. Maximizing the capability of all focus points, the D4S's dynamic-area AF mode (51 points) provides the autofocus versatility needed for elusive subjects, such as the bird pictured above.

• Lens: AF-S NIKKOR 300mm f/2.8G ED VR II • Image quality: 14-bit RAW (NEF) • Exposure: [S] mode, 1/4000 second, f/9 • White balance: Auto 1 • Sensitivity: ISO 3200
• Picture Control: Standard © George Karbus



Reliability to nail the shot at high ISO, maintaining smooth, rich tonal gradation

Venture out into nature with the D4S, even under a grey stormy sky or on a rainy night. Combined with a durable and water-resistant body, the high ISO capability of the D4S lets you take your art to wild new places.

• Lens: AF-S NIKKOR 70-200mm f/2.8G ED VR II • Image quality: 14-bit RAW (NEF) • Exposure: [A] mode, 1/400 second, f/18 • White balance: Auto 1 • Sensitivity: ISO 3200
• Picture Control: Landscape © George Karbus





In the world of sport, it takes a specific combination of factors to become a champion. The same can be said for photographers who cover the athletic drama as it unfolds. To render an athlete's story with all the physical and emotional intensity it deserves, the photographer needs gear that meets the most rigorous demands. To do this consistently, however, capturing images that win the attention of editors and audiences around the world, the camera must go even further.

The D4S is that camera.

With all the speed and power you expect from a new Nikon flagship, the D4S is packed with expanded features and versatility. Put simply: it shoots what you want, where you want, faithfully following your intentions with an incredibly accurate initial AF detection and AF tracking performance, even at high magnifications or after sudden changes in your subject's distance. You get incredible JPEG image quality straight out of the camera, including a new level of depth, sharpness and malleability. Video capabilities are more powerful and versatile than ever, with a new 1080/60p and shockingly sharp 1920 × 1080 crop mode that must be seen to be believed.

The bar has been raised. Whether near or far, the D4S shoots pictures that were once unattainable. Even in extremely difficult shooting situations, the D4S captures pictures that sell.



All-round professional performance: a true gearshift



Track your subject more confidently for a striking composition, without any cropping.

• Lens: AF-S NIKKOR 400mm f/2.8G ED VR • Image quality: 14-bit RAW (NEF) • Exposure: [M] mode, 1/1250 second, f/2.8 • White balance: Auto 1 • Sensitivity: ISO 4000 • Picture Control: Standard © Robert Beck

Unbeatable AF accuracy and versatility

- New algorithms to further empower the accurate AF acquisition of extremely fast and erratically moving subjects, both near and far
- Tenacious AF tracking to frame fast-approaching or receding subjects up-close for a dynamic, professional composition
- Swift and strategic AF-area mode selection via focus operation buttons on super-telephoto NIKKOR lenses, for optimized AF in any situation

Accurate AF acquisition and powerful tracking to push professionals further, even in extreme situations

Expect an entirely new level of AF performance — one where you can conquer aesthetic goals while winning your editor's approval. After listening to countless professionals who compete in this truly demanding field, Nikon responded with a new and inspired AF system — the ultimate focusing performance for professionals who face extreme situations day in and day out. With its thoroughly recalibrated AF algorithms, the Advanced Multi-CAM 3500FX autofocus sensor module quickly zeros in exactly where and how you intend — no matter how near, far, or abruptly your subject appears in the scene. Expect detection accuracy, even for subjects in low-contrast situations. The detected subject stays in constant focus, thanks to bolstered tracking capabilities. Imagine a speed skater hurtling toward you: the D4S lets you track the subject more confidently until the frame is filled with a more aesthetically striking composition. The days of constantly shooting loose for safety are over. This same high-level AF performance applies to a wide array of challenging situations that today's sports shooter must face. Moreover, tracking performance remains powerful even when the view of your intended subject is momentarily obstructed, such as during a football or rugby match. With true AF versatility like this, the D4S helps you capture more winning images in any situation.



The accurate autofocus of the D4S swiftly locks onto a downhill skier that flies into the frame at top speed from an unseen position.

• Lens: AF-S NIKKOR 800mm f/5.6E FL ED VR • Image quality: 14-bit RAW (NEF) • Exposure: [M] mode, 1/2500 second, f/7.1 • White balance: Direct sunlight • Sensitivity: ISO 2000 • Picture Control: Standard © Robert Beck

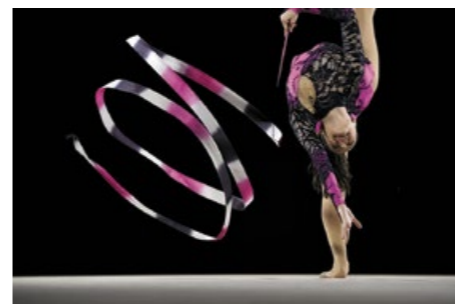

Expect sharp focus even in the most erratic movement, for example, when a rhythmic gymnast suddenly and quickly bends back. © Dave Black



Even a tiny window of time is enough for the D4S to capture a butterfly swimmer that appears for a fraction of a second. © Dave Black



Even in a game where the main subjects constantly change, the D4S's autofocus is never fooled. © Robert Beck

Versatile AF-area modes for varying professional needs

The D4S further empowers its flagship focusing versatility. In addition to the four time-tested modes (single-point AF, dynamic-area AF, auto-area AF, and 3D-tracking) a fifth AF-area mode option is now available. The new group-area AF focuses more securely on your desired subject by using five AF points simultaneously like a net, in contrast to dynamic-area AF which uses one initial AF point. This can be extremely useful when targeting unpredictable subject matter that is hard to lock on to — all while avoiding unintentional focus on the background. Photographers can now feel more confident, knowing that small, distant and fast-moving objects can be captured quicker, more successfully, and rendered sharper.

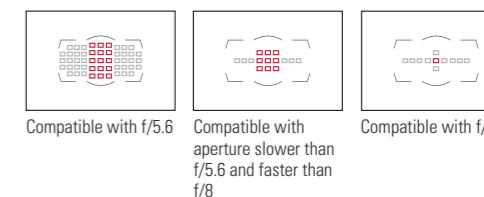
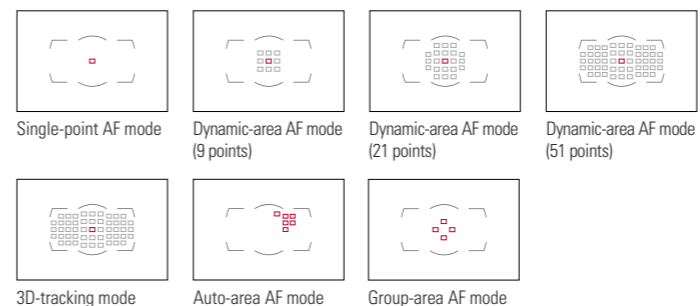

- Perform as cross-type sensors
- Perform as line sensors

Strategic, swift AF-area mode change via focus operation buttons on super-telephoto NIKKOR lenses

A good game plan leads you toward the shots you want. For example, most sports shooters rely heavily on dynamic-area AF mode with nine points, but there might be moments during a single game or performance when a different AF-area mode would be more appropriate. You may prefer single-point AF mode for pinpoint focus on an athlete's eye, but then moments later need other dynamic-area AF modes or group-area AF mode if the same subject begins to move unpredictably. With the D4S, your super-telephoto NIKKOR's focus operation buttons work as a strategic shortcut to one pre-registered AF-area mode. Now you can switch back and forth between your two most vital modes instantly, and without ever taking your eye away from the subject. Simply press to switch modes, and then release to return to the previous mode.



Single-point AF mode

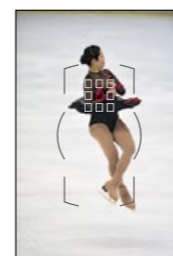

Dynamic-area AF mode (9 points)



Group-area AF mode

Note: Switching to the pre-registered AF-area mode is not possible when 3D-tracking is selected on the camera while using autofocus.

AF strength with diverse NIKKOR lens and teleconverter combinations

The D4S features 51 focus points with 15 cross-type sensors in the center area of the viewfinder, expertly detecting contrast in both vertical and horizontal directions for better AF performance. All 51 points are responsive to f/5.6 and deliver a full performance with all AF-NIKKOR lenses. In addition, the center nine points, as well as three points to the left and right of these nine, are compatible with apertures slower than f/5.6 and faster than f/8. The result: stress-free focusing when using 1.4x or 1.7x teleconverters. Moreover, 11 focus points are even compatible with f/8, thereby giving you significant AF power when combining a 2.0x teleconverter with super-telephoto NIKKOR lenses.



Focus operation buttons



JPEGs right out of the camera maintain sharpness that's ready for publication, even after aggressive cropping.

• Lens: AF-S NIKKOR 70-200mm f/2.8G ED VR II • Image quality: JPEG fine • Exposure: [M] mode, 1/2000 second, f/4.5 • White balance: Cloudy • Sensitivity: ISO 320 • Picture Control: Standard © Robert Beck

Winning image quality for when speed means business

- Stunning sharpness, healthy skin tones and enhanced depth in JPEGs straight out of the camera
- Powerful EXPEED 4 image-processing engine for clear images with minimized noise from ISO 100 to 25600
- Versatile auto white balance and convenient Spot White Balance that deliver accuracy with speed — indispensable for professionals

Stunning image quality directly ready for the world

For many of today's professional photographers, winning images are expected to be online within seconds of capture. In order to grab and keep a photo editor's attention you need out-of-the-camera image quality — once an image is shot, it must be ready to publish without requiring post-production. The D4S is designed with this specific goal in mind. Within seconds of pressing the shutter-release button, the world will witness an entirely new level of image sharpness, tonal richness and depth in your pictures. Skin tones are warmer, more natural-looking and devoid of image-degrading noise at high ISO settings. You can expect the same quality even when shooting under difficult light sources such as at poorly lit gymnasiums and stadiums at night. Images impress at first glance, but the sharpness stands up to any level of closer scrutiny as well, with photos maintaining their winning attributes even after the aggressive cropping required for publishing in magazines, newspapers and on websites. Capture

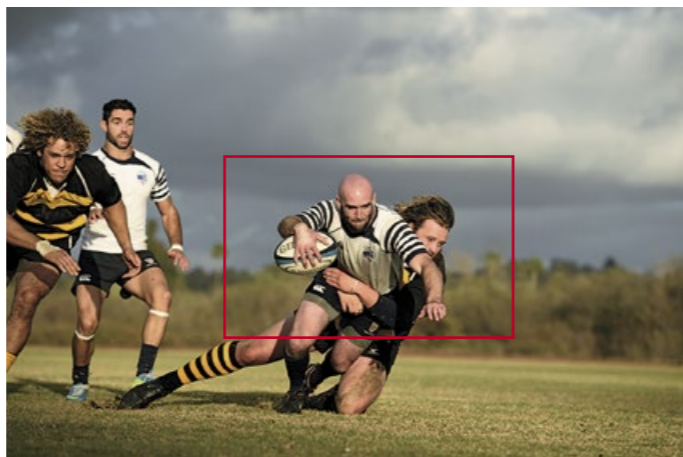

Original framing of the image shown above, before cropping.
© Robert Beck

an athlete's face with the D4S and then closely inspect every detail of the image. Only then will you understand the kind of immediate respect that the D4S commands.

A whole new level of clarity with unprecedented noise reduction

From its standard range of ISO 100 to ISO 25600, the D4S delivers consistently sharp edges and clean colors — achieved through Nikon's own meticulous and uncompromising testing procedures. Nikon is constantly improving its noise-control expertise. The powerful EXPEED 4 image-processing engine incorporates an entirely new algorithm for noise reduction at high ISO and color fidelity, resulting in an enhanced at-a-glance overall sharpness and clarity without sacrificing subtle textures and luminous details. Image quality is retained even when noise-reduction levels are set at "High." Noise is kept to a minimum even on flat planes in the mid-tonal range. Combined with the camera's many other image-processing enhancements, your images will retain deeper tones, a healthier saturation and project an overall bolder look. Even within the realm of professional gear, the D4S's image quality reaches a new level of achievement. See for yourself.

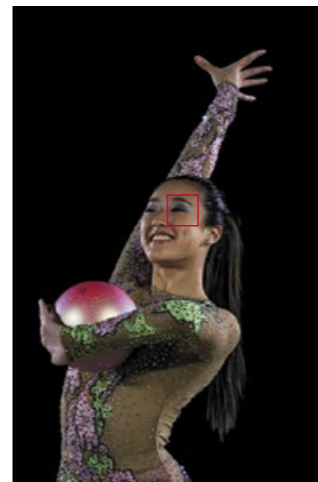

ISO 6400



ISO 1600

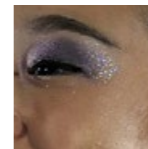

ISO 3200

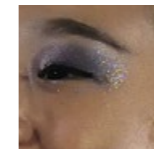

ISO 12800

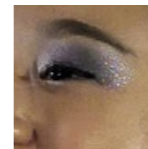

ISO 25600

Formidable technologies at the heart of your images



Every winning shot you take with the D4S is made possible by a formidable quartet of exclusive Nikon imaging technologies. The newly designed FX-format CMOS image sensor offers 16.2-megapixel resolution and a remarkably wide light sensitivity range: ISO 100 to 25600 as standard without sacrificing dynamic range, which can be expanded to the equivalent of ISO 50 to 409600. The perfect accompaniment to such a sensor is the NIKKOR line of lenses. Unmatched in sharpness, clarity and accuracy, each lens draws out the full potential of the D4S's sensor in diverse lighting conditions. The powerful EXPEED 4 image-processing engine receives 14-bit A/D-converted data from the sensor and conducts comprehensive 16-bit processing to maintain your image information's peak richness without losing speed. Power is used intelligently: expect between 3020 shots^{*1,3} (single-frame release mode) and 5960 shots^{*2,3} (continuous release mode) on a single battery charge. Lastly, there is the exceptional Picture Control System, which realizes images that exemplify Nikon's highest standards, but also allows professionals to define their own look by controlling a variety of imaging parameters both in stills and videos.

*1 Based on CIPA Standards.

*2 Based on Nikon testing.

*3 When using an XQD card.

Healthy skin tones with accurate white balance

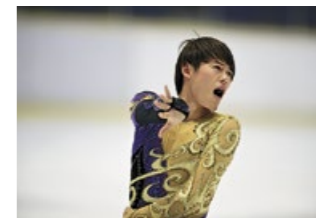

Accurate auto white balance renders healthy skin tones.

EXPEED 4 image-processing engine uses a new, intelligent algorithm for auto white balance that more accurately detects light sources through rigorously detailed image analysis. This significantly contributes to healthier-looking, better-saturated skin tones under a diverse range of light sources. Each white balance option, including auto, can also be calibrated in even finer steps than before for a more granular control of color. In addition, the camera's new Spot White Balance feature allows you to calculate on-the-spot preset manual white balance during live view using a tiny data acquisition area selected in your frame. Attaining the level of accuracy that professionals demand, any preset data acquisition area you set will maintain its size even when the live view image is magnified. If you're not satisfied with the result, simply move the acquisition area manually to receive a new Spot White Balance reading. Do this as many times as needed, all without repeating the process from the beginning — another real-world convenience delivering efficiency that professionals will appreciate.

Nikon's exclusive Advanced Scene Recognition System

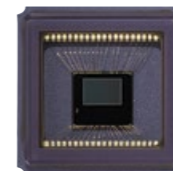

91K-pixel RGB sensor

Professionals can confidently rely on the D4S for accuracy and seamless synergy of crucial camera controls such as autofocus, auto exposure, auto white balance and i-TTL flash exposure. Using its 91K-pixel RGB sensor that also functions as a precision metering sensor, the D4S's Advanced Scene Recognition System studies each shooting scenario for brightness, contrast, color, distribution of highlights, and even the existence of human faces. It then applies this information to achieve the best scene analysis possible — accurately, and all in milliseconds before shutter release, with every image you take, even during high-speed continuous shooting. Silently and subtly, the Advanced Scene Recognition System works in the background to help you achieve the best images possible. Expect more powerful focus tracking, tack-sharp focus on faces, well-balanced exposures that retain highlights, and even more faithful white balance. The system also utilizes information from the image sensor for magnified playback of your subject's face, as well as auto exposure and autofocus control of live view shooting, including video.



Adjusting Picture Control can either subtly or significantly enhance the look of your images, while maintaining photographic integrity.
 • Lens: AF-S NIKKOR 800mm 1/5.6E FL ED VR • Image quality: 14-bit RAW (NEF) • Exposure: [S] mode, 1/3200 second, 1/11 • White balance: Auto 1 • Sensitivity: ISO 3200 • Picture Control: Switched to "Vivid" and adjusted in post-production
 © George Karbus

Enhanced professional artistry, all under your control

- Excellent file malleability and Nikon's Picture Control System maintain image integrity while expanding creative freedom
- Nikon Creative Lighting System with "Background only" exposure compensation option separate from flash compensation
- Active D-Lighting to retain more highlight and shadow details in harsh light for natural-looking results — unique to Nikon

Enhanced artistry for professionals — Nikon's Picture Control System

The D4S delivers exceptional image quality in every default-setting JPEG straight out of the camera, but the benefits don't stop there. The superior malleability of the camera's image files means that professionals can easily expand on their artistic impact by taking advantage of Nikon's original Picture Control System. Simply apply a preset Picture Control option according to your preference, and enjoy the distinctive images. Slightly adjust the parameter sliders to further enhance the look. You can even create custom Picture Controls by modifying preset options using the Picture Control Utility* on a PC. The Picture Control System lets you fully explore each picture's photographic potential without compromising the image's integrity.

*Software accessible from ViewNX 2 (supplied with the D4S) or Capture NX 2 (optional).



Original picture taken with the "Landscape" Picture Control option

The appearance of the original picture was significantly modified in post-production by switching the Picture Control to "Vivid," with parameters fine-tuned using the Picture Control Utility and further enhanced using the Color Control Points in Capture NX 2. The modified picture is shown at the top of this page.

Give your images an extra edge by experimenting with Picture Controls

Try applying preset Picture Controls to unusual subject matter as a means of discovering a different look or style for your photography

"Landscape" creates more impressive contrast in portraits



Shot with "Portrait"



Shot with "Landscape" with parameters fine-tuned



"Portrait" enhances the soft, smooth appearance of landscape shots



Shot with "Portrait"

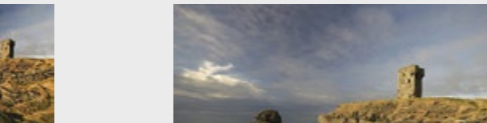

Shot with "Portrait" with parameters fine-tuned

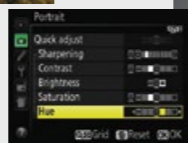

Nikon Creative Lighting System: studio-level lighting, virtually anywhere

Moving beyond available light is easy with Nikon's unbeatable Creative Lighting System (CLS). Portable Nikon Speedlights (optional) can transform any location into your own personal studio, using the diverse array of CLS flash features to add more depth and dynamism to your images. Advanced Wireless Lighting gives you precise control of remote flash units: control up to three groups of Speedlights, with an unlimited number of units in each group. Operation is as intuitive as controlling an on-camera Speedlight, using a simple, easy-to-understand interface. Thanks to Nikon's exclusive i-TTL flash control, results will be accurate. In addition, the D4S offers an exposure compensation option that affects only the background of your image. Unlike the entire frame compensation option that changes both flash and the background exposures, this feature allows photographers to emphasize what they want most in their composition without complicated calculations.



Auto FP high-speed sync was achieved using four remote SB-910 Speedlights which were wirelessly controlled from the SU-800 commander attached to the D4S.

• Lens: AF-S NIKKOR 24-70mm 1/2.8G ED • Image quality: 14-bit RAW (NEF) • Exposure: [M] mode, 1/2500 second, f/6.3 • White balance: Auto 2 • Sensitivity: ISO 160 • Picture Control: Standard © Dave Black



No exposure compensation for the subject and the background



"Background only" exposure compensation (-2 EV)



"Entire frame" exposure compensation (-2 EV)



Improved response for single Speedlight i-TTL flash exposures

The D4S provides enhanced response for i-TTL flash exposures employing one Speedlight by further optimizing monitor pre-flashes. The camera swiftly conducts i-TTL flash control to give you the optimum results without missing critical moments: an advantage you appreciate best during continuous shooting.

Active D-Lighting with "Extra high 2" option

When working with extremely high-contrast lighting, such as in backlit conditions exceeding the camera's already broad dynamic range, the D4S's Active D-Lighting feature provides the unique capability to preserve details in both highlights and shadows. It does this while maintaining appropriate contrast and a natural photographic look. The powerful EXPEED 4 image-processing engine achieves high color fidelity with shorter processing time — working in real-time as you shoot. In the harshest lighting conditions, try the "Extra high 1" or "Extra high 2" option. Active D-Lighting works with a single shutter release, and can prove very effective when movement is inherent to your image.



Extra high 1

HDR (High Dynamic Range)

In the HDR mode, the D4S combines two images taken at different exposures (differential can extend up to 3 EV) in one shutter release to create a single frame that covers a wider latitude than the camera's native dynamic range. The smoothness of the edges where the two exposures meet can be adjusted. Most suitable for landscapes, interiors and studio work, the resulting images maintain rich saturation and tonality with minimum noise.

Note: Tripod use is recommended.



Exposure differential: 3 EV, Smoothing: normal

Setting minimum shutter speed to avoid image blur for auto ISO sensitivity control

In the auto ISO sensitivity control option, the camera automatically adjusts ISO sensitivity when it cannot achieve the correct exposure at the selected sensitivity. Maximum sensitivity can be set from ISO 200 to Hi 4. In P or A mode, the minimum shutter speed to activate auto ISO sensitivity control can be selected from 1/4000 to 30 s. If the brightness of your subject matter is constantly in flux, such as when clouds are moving rapidly overhead or for shooting in a partially shaded sports area, select fast shutter speed as the minimum shutter speed in order to avoid unintended blur. Using the auto option when setting the minimum shutter speed, the D4S will automatically choose the shutter speed that activates auto ISO sensitivity control based on the focal length of the attached lens — very useful when shooting with a zoom NIKKOR lens.



Four image area options

The combination of the D4S and NIKKOR lenses provides you with unprecedented versatility. Aside from FX format (36.0 × 23.9 mm), the D4S also shoots with a 5:4 crop (29.9 × 23.9 mm) and 1.2x crop (29.9 × 19.9 mm), as well as DX format (23.4 × 15.5 mm). The last two are approx. 1.2x or 1.5x options, which can be extremely useful for creating telephoto effect to an existing lens.

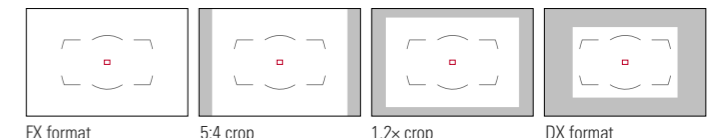

FX format

5:4 crop

1.2x crop

DX format



Clear viewfinder visibility during high-speed continuous shooting lets you better track any subjects.

• Lens: AF-S NIKKOR 70-200mm f/2.8G ED VR II • Image quality: 14-bit RAW (NEF) • Exposure: [M] mode, 1/1600 second, f/4.5 • White balance: Auto 2 • Sensitivity: ISO 3200 • Picture Control: Standard © Dave Black

A cutting-edge workflow without cutting corners

- Clear subject view with minimized image blur caused by mirror movement gives better tracking results during high-speed continuous shooting
- A wide range of practical customization options to handle diverse professional needs
- Built-in wired LAN terminal (1000BASE-T) for fast data transmission

New mirror-movement mechanism for better viewfinder visibility while tracking subjects in high-speed continuous shooting

The D4S's inspired image quality and AF performance can only reach their full potential if a photographer has a clear view of what he or she is shooting. Even when capturing fast, erratically moving subjects using high-speed continuous shooting, the D4S maintains a clear view of your target so you can better track agile subjects. To achieve this, Nikon's newly designed mirror-moving mechanism employs double mirror balancers for the main mirror, that effectively absorb mirror slap. Also incorporated are dedicated receptacle pins on both sides of the sub-mirror, that swiftly and accurately stop the mirror movement. Both contribute to accurate AF tracking during 11-fps high-speed continuous shooting with full-time AF and AE compatibility, in which the viewfinder image is more stable with

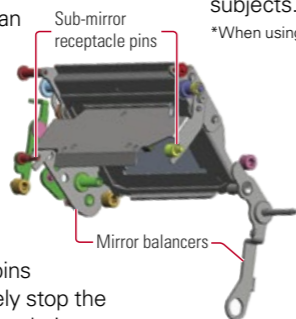

minimized image blackout time, maintaining this clear view for up to 200 JPEG shots* nonstop. Moreover, a selected focus point stays constantly illuminated without blinking in the viewfinder at every shutter release during high-speed continuous shooting, helping a photographer concentrate when tracking fast and erratically moving subjects.

*When using a 32 GB Sony S-series QD-S32E XQD card.

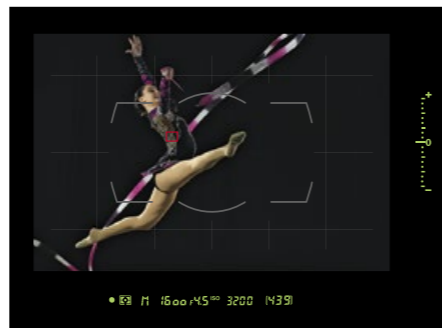

Minimized viewfinder blackout time combined with a constantly illuminated focus point display enhances your visual concentration during high-speed continuous shooting.

© Dave Black

The D4S lets you shoot at 11 fps with full AF and AE performance, and maintains high speeds at any aperture.

© Dave Black



Total workflow speed to keep you at the top of your game

Strategic preparation prior to shooting for effective results

Customizing AF functions for surer controls

The D4S's AF functions are ready to be customized to serve more attentively to a professional's many needs. In addition to being able to store separate focus point selection for horizontal and vertical compositions, you can now do so with different AF-area modes as a set by camera orientation. With preset focus point customization, you can return to the designated focus point at the push of a button. To avoid choosing unintended lens servo and AF-area mode combinations, the D4S lets you customize and stay only with the modes you want.

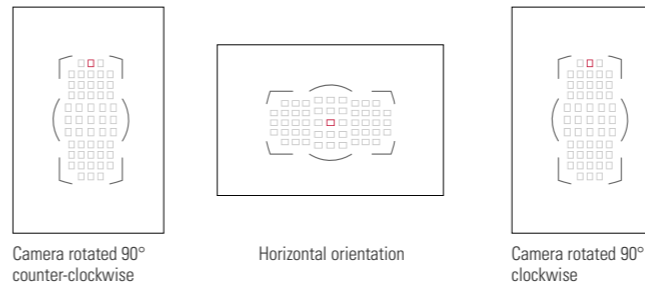

A different focus point can be selected for each camera orientation.

Color customization of LCD monitor

Careful preparation leads to better results. The D4S's LCD has been meticulously calibrated to display correct colors. In addition, you can adjust the color balance of the LCD monitor to your preference.

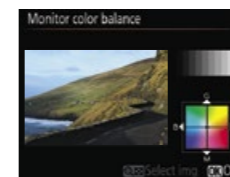

Enhanced professional operability and reliability during the shoot



Minute changes in body contours, button locations and textures

Once in their hands, professionals will feel the D4S's operational enhancements. The fine-tuned contour of the grip makes holding the camera even more secure for both horizontal and vertical compositions. The AF-ON buttons for horizontal and vertical shooting have been slightly adjusted for better location and a more confident press. The sub-selector incorporates new material and surface design for enhanced operability. Every detail has been carefully considered, subjected to uncompromising scrutiny in order to give you the best speed and performance possible.

Faster image processing with EXPEED 4 and RAW size S

The D4S offers a variety of fast and efficient ways to deliver quality images to your editor or any other audience. If your mission is to send JPEG images without a post-production edit, then rely on EXPEED 4 for 30% faster processing while maintaining an unprecedented level of image quality. If you need both post-production enhancement and speed, the D4S lets you shoot in RAW size S* (12 bit, uncompressed), which has a quarter of the resolution of RAW size L (12 bit, uncompressed; the file size of RAW size S is about a half) while maintaining sharpness and noise level equivalent to JPEG size S. *Some retouch options, such as NEF (RAW) processing and image overlay, cannot be applied

Comprehensive professional reliability

As the ultimate in professional gear, expect no compromise regarding camera durability. From the light and durable magnesium-alloy body with moisture- and dust-proof sealing, to the shutter unit tested over 400,000 times in fully assembled models, the D4S is ready for a diverse range of demanding assignments, with dual card slots for high-speed memory cards (one for XQD and the other for CF) to capture shot after winning shot. You can even shoot in darkness, with illuminated buttons that make camera operation easy. The clear optical viewfinder offers approx. 100% frame coverage.

Faster image transmission almost simultaneous with capture

Built-in wired LAN terminal compatible with 1000BASE-T

A professional's workflow is only complete once the image is delivered. To help achieve your objectives with speed, the D4S allows high-speed data transmission (transmission speed of a JPEG size L image is three times faster than the D4) with a built-in wired LAN terminal (1000BASE-T), that sends images in your preferred format (JPEG, NEF [RAW] or TIFF) to an editor in fractions of a second. To save photographers the time-consuming chore of attaching the attributes of each image (i.e. author, theme, venues, etc.), the D4S lets you register IPTC data prior to the shoot.

Optional WT-5A/B/C/D Wireless Transmitter

Small and light, the WT-5A/B/C/D connects to the D4S for powerful wireless data transmission. It is compatible with IEEE802.11n (1x1 HT40: max. 150 Mbps) as well as IEEE802.11a/b/g for enhanced speed.

Network capabilities of wired LAN or WT-5A/B/C/D

With the wired LAN or WT-5A/B/C/D Wireless Transmitter, you can transmit still and video data stored in the camera's memory card as well as "just captured" still images to an FTP server or a computer. Also available are remote shooting from a computer via Camera Control 2 software (optional), and transferring and storing of stills or movies on a computer. In HTTP server mode, you can view still images stored on the camera's memory card and conduct remote shooting via a web browser on a computer or an iPhone. Attaching the WT-5A/B/C/D to the D4S or the D4, configured as a master camera, enables synchronized release of up to 10 remote D4S or D4 cameras, each with a WT-5 unit attached.





1080/60p Full HD video combined with high ISO performance renders smooth motion with minimum noise.

Advanced video versatility, amazing multimedia

- 1080/60p Full HD video with EXPEED 4, rendering rich, smooth tones with minimized noise from ISO 200 to 25600
- 1920 x 1080 crop mode delivers stunning sharpness without resizing, with an approx. 2.7x increase to focal length
- Smooth exposure transition in time-lapse and interval timer photography of scenes with gradually changing brightness

1080/60p Full HD video with full manual control and wide standard ISO range of 200 to 25600

Professional assignments rarely happen in ideal conditions, whether shooting still images, running a video production, or both. Photojournalists who shoot video often need to move quickly, with as little equipment weighing them down as possible. The D4S reliably delivers amazing, broadcast-quality video in such environments, with 1080/60p Full HD capability packed into its rugged body. Thanks to its optimized image processing, the camera produces videos displaying stunning sharpness and depth — even the small details are free from moiré and jaggies. The wide standard ISO range — from 200 to 25600 — also helps professionals achieve their objectives using the D4S alone, all without needing to drag along cumbersome additional lighting equipment. When working in extremely dark situations, the ISO can be pushed up to an ISO 409600 equivalent. Select a frame rate that matches your intentions, choosing from 60p, 50p, 30p, 25p, and 24p. The 60p frame rate is ideal for capturing smooth motion.



The D4S with its high ISO performance lets a videographer move fast with a minimum amount of equipment.

Powerful EXPEED 4 for smooth exposures, rich tones and minimum noise

In addition to smooth motion capture, the D4S also renders exposure transitions smoothly. When a scene's exposure changes significantly, such as filming at dawn or panning from one light level to another, the D4S's image sensor and EXPEED 4 work hand-in-hand to render a natural transition between bright and dark scenes, all while delivering rich tones, sharp edges and minimized noise, even at high ISOs.



The D4S's image sensor and EXPEED 4 ensure smooth exposure transition in a video sequence that moves between dark and bright environments, something that was previously impossible.

Multi-area mode Full HD video with the stunningly sharp 1920 x 1080 crop mode

Professionals have to travel light, but they also need plenty of creative options. When working in multimedia, having more visual options for your footage can be the key to success, but it can also mean carrying lots of extra gear. The design of the D4S addresses this head-on, essentially serving as three cameras in one. Its multi-area modes allow you to shoot with three different areas of the image sensor: FX-based format, DX-based format, and 1920 x 1080 crop format. While the FX-based format offers a shallower depth of field and better noise performance, the DX-based format and 1920 x 1080 crop format offer deeper depth of field and a further extended focal length of the lens in use — 1.5x with the DX format and 2.7x with the 1920 x 1080 crop. For exceptional sharpness in video images, the 1920 x 1080 crop format uses exactly 1920 x 1080 pixels to achieve 1080p

Full HD. The result is simply amazing image sharpness. By changing modes, your NIKKOR lenses, including DX NIKKORs, can double and triple their utility, which can be an immense help when carrying additional lenses is difficult or impossible.



- FX-based format
- DX-based format
- 1920 x 1080 crop

The image above shows three image area options (aspect ratio 16:9) on an FX-format image area for viewfinder shooting or live view photography.

Professional operability

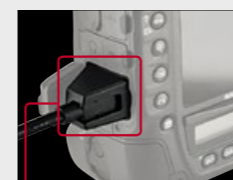

HDMI Cable Clip

Uncompressed HDMI output of 1920 x 1080/60p to an external recorder

For the purest video quality, the D4S allows direct output of uncompressed files via HDMI. Output can be edited using the ProRes* format, making for an efficient editing workflow. New to the D4S is the ability to record video in the camera (compressed in the H.264/MPEG-4 AVC format) while simultaneously outputting uncompressed files. Using the optional HC-E1 HDMI Cable and the supplied HDMI Cable Clip, you can also expect stable operation without accidental dislocation of the cable. The cable clip also prevents the cable connector from being damaged.

*ProRes is a codec by Apple Inc. and is a registered trademark of the company.

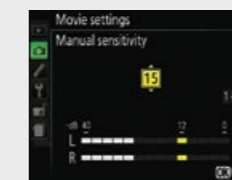

Hi-fi sound control before and during recording via stereo headphones and audio level monitoring

The D4S is designed for crisp audio recording with an external stereo microphone connector. Attach the compact ME-1 Stereo Microphone (optional) to record high-quality sound while significantly reducing mechanical noise. A headphone connector enables use of headphones to effectively monitor and control audio in sonic isolation. The sound level indicators offer visual confirmation of your audio level, and the microphone sensitivity can be controlled precisely in 20 incremental steps. You can also select "Wide range" (for recording musical performances or the ambient sound of city streets) or "Vocal range" (for recording human voices). When recording with the built-in microphone, you can apply wind noise reduction.



Smoother exposure transition during time-lapse and interval timer photography

Creating breathtaking time-lapse movies is even easier with the D4S. In a time-lapse movie of scenes where the brightness changes gradually, such as at dawn or dusk, even a slight difference of exposure of each frame can create annoying flickering. The D4S intelligently measures exposure variances and renders the transitions with unprecedented smoothness. Such scenes have previously been difficult to capture, but

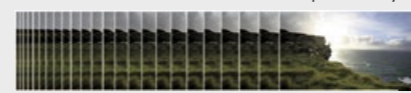

interval timer shooting. The maximum number of exposures available in interval timer shooting is 9999, increased from 999 with the D4.

now you can confidently apply auto exposure to achieve professional-grade time-lapse and



Index marking can be registered during recording for efficient editing

Save valuable time using the index-marking feature, which lets you designate important frames while filming. This makes it easy to locate key points in your footage during the later stages of in-camera editing. Markings are indicated along with the progress bar, and are easy to confirm visually.

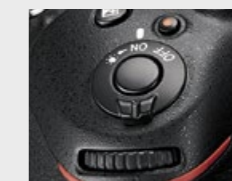

Option to tailor the shutter-release button to start/finish video recording

The D4S's custom function allows you to customize the shutter-release button as a movie recording start/finish button. This means that you can shoot video remotely with either a remote cord or the WR-1 Wireless Remote Controller, even when the camera is placed at a distant or less accessible location, such as on a remote-controlled helicopter for aerial shooting.

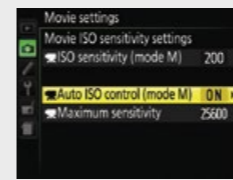

Auto ISO control while shutter speed and aperture are fixed

Imagine you are shooting a long sequence that starts in a dark corridor and ends in the bright outdoors. The D4S lets you maintain manual exposure for controlled shutter speeds and aperture settings while the camera automatically dictates the sensitivity for the correct exposure. Maximum sensitivity can be set from ISO 400 to Hi 4. For assignments with dramatic shifts in lighting, this can be a remarkably useful tool.

Power aperture for smooth aperture control during recording on an external HDMI device

Instead of rotating the sub-command dial, power aperture* allows you to fine-tune aperture settings during movie live view by using the preview button and a function button that you can designate via the custom menu. Power aperture is compatible with recording on an external device via HDMI.

*Available in A and M modes.



• Lens: AF-S NIKKOR 800mm f/5.6E FL ED VR • Image quality: 14-bit RAW (NEF) • Exposure: [M] mode, 1/2500 second, f/5.6 • White balance: Auto 1 • Sensitivity: ISO 500 • Picture Control: Standard © Dave Black

NIKKOR lenses: The defining strength for winning photographs and videos

- Exceptional sharpness, from the image center to the periphery
- Sharp resolution that renders a point light source as a point
- Smooth transitions from sharp focus to soft bokeh, faithfully defining three-dimensional space in your images
- Image clarity free from ghost and flare in difficult lighting

NIKKOR lenses: Optical masterpieces for Nikon D-SLRs

Whether they shoot with Nikon or not, professionals unanimously praise the exceptional optical performance of NIKKOR lenses. Realizing the full professional quality and performance of Nikon's newest flagship, NIKKOR lenses represent the clear advantage of shooting with the Nikon system. As long as professionals continue to strive for better image quality, Nikon's designers will tirelessly refine their lens technologies to produce the best images possible. While NIKKOR lenses continue to advance, they will always inherit Nikon's timeless lens-making standards: point light sources reproduced as point images, high resolution even at the periphery, natural bokeh accompanied by natural depth, and reduced ghost and flare. NIKKOR lenses are engineered based on Nikon's strict lens-making criteria, and fulfill the demands of professionals in both video and still image shooting. This level of optical performance is unmatched by any other lens maker. Trusted by still photographers and video professionals alike, NIKKOR lenses are held in the highest regard across the industry. The incredible variety of NIKKOR lenses available gives you an unbeatable array of options to select the most suitable lenses for both still and video usage, so you can achieve the very best quality image in any shooting situation.



85 million
NIKKOR



• Lens: AF-S NIKKOR 14-24mm f/2.8G ED • Image quality: 14-bit RAW (NEF) • Exposure: [M] mode, 1/8 second, f/18 • White balance: Color Temperature (3030K) • Sensitivity: Lo 1 • Picture Control: Standard © Dave Black

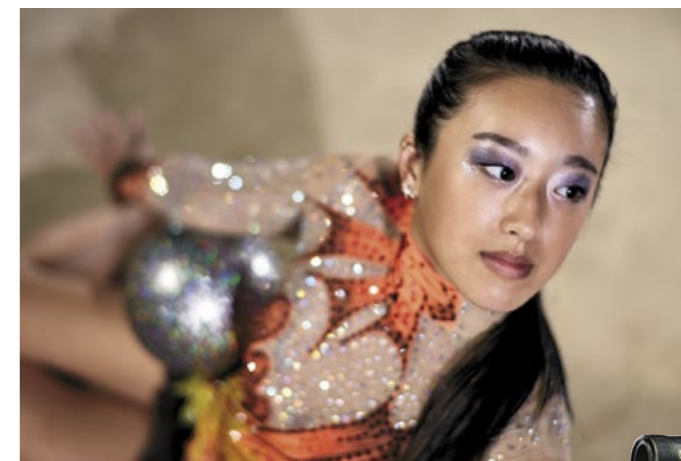

• Lens: AF-S NIKKOR 58mm f/1.4G • Image quality: 14-bit RAW (NEF) • Exposure: [M] mode, 1/640 second, f/1.8 • White balance: Auto 2 • Sensitivity: ISO 400 • Picture Control: Standard © Dave Black



AF-S NIKKOR 24mm f/1.4G ED

A fast wide-angle lens, producing amazing sharpness and bokeh while covering an 84° angle of view. Ideal for handheld shooting of night landscapes or interiors with poor lighting. Clear images with reduced flare and ghost are easily rendered thanks to Nano Crystal Coat.



AF-S NIKKOR 35mm f/1.4G

This wide-angle prime lens delivers stunning images with natural bokeh while achieving a remarkable level of coma aberration correction, even at the maximum aperture. Nano Crystal Coat reduces ghost and flare in harsh lighting. The most suitable lens for nature, landscapes and starlit skies.



AF-S NIKKOR 58mm f/1.4G

A fast, standard prime lens offering high resolution and the superb look of beautiful, continuous bokeh and natural depth. In night landscape shooting, the lens defines point light sources as point images even in the peripheral areas at the maximum aperture. The exquisite bokeh depicts subjects even more attractively in portrait or still-life shooting.



AF-S NIKKOR 14-24mm f/2.8G ED

This award-winning, wide-angle zoom lens exemplifies the NIKKOR spirit, with edge-to-edge sharpness across the frame. Nano Crystal Coat and aspherical lenses including large-diameter PGM elements ensure outstanding image quality, even in backlit conditions. An essential lens for every situation a professional photographer can encounter.



AF-S NIKKOR 24-70mm f/2.8G

This standard zoom lens achieves natural optical fidelity and fine sharpness throughout the zoom range, while maintaining the maximum aperture of f/2.8. Praised not only for its image quality but also for its reliability. Great versatility for a remarkably wide range of subject matter.



AF-S NIKKOR 70-200mm f/2.8G ED VR II

A telephoto zoom with impressive Vibration Reduction (VR) support of up to 3.5 stops*, thereby offering more handheld shooting opportunities. Expect beautiful bokeh from infinity to the 1.4 m/4.6 ft minimum focus distance, while Nano Crystal Coat minimizes flare and ghost.



AF-S NIKKOR 200-400mm f/4G ED VR II

This super-telephoto zoom keeps weight to a minimum during super-telephoto assignments that require stunning image quality. Nano Crystal Coat and VR support (up to 3.0 stops*) contribute to sharper images under demanding conditions.



AF-S NIKKOR 200mm f/2G ED VR II

A super-telephoto lens that delivers crystal-clear images, with ED and Super ED glass reducing chromatic aberration while Nano Crystal Coat minimizes flare and ghost. Handheld shooting is made possible thanks to VR support (up to 3.0 stops*) and a fast f/2 maximum aperture.



AF-S NIKKOR 300mm f/2.8G ED VR II

This large-aperture telephoto lens, renowned for professional use, enables handheld shooting with VR support (up to 3.0 stops*). Nano Crystal Coat reduces ghost and flare effects, helping to create stunningly crisp, clear images. The best choice for indoor and action sports.



AF-S NIKKOR 400mm f/2.8G ED VR

A super-telephoto lens delivering incredibly sharp images and beautiful bokeh with a fast f/2.8 maximum aperture, VR support (up to 3.0 stops*), and Nano Crystal Coat. The light and durable magnesium die-cast lens barrel means true reliability.



AF-S NIKKOR 500mm f/4G ED VR

This powerful super-telephoto lens offers incredible image reproduction. Featuring VR support (up to 3.0 stops*) and Nano Crystal Coat, the light and durable lens design gives you added confidence when out in the field. Ideal for motor sports, outdoor athletics and wildlife.



AF-S NIKKOR 800mm f/5.6E FL ED VR

The longest of all the NIKKOR lenses maintains a very lightweight body, allowing you to produce amazingly clear super-telephoto images by employing fluorite, ED glass and Nano Crystal Coat in its construction. The VR function offers a powerful effect equivalent to shutter speeds 4.5 stops* faster. An electromagnetic diaphragm mechanism ensures stable aperture control even when the lens is used with the dedicated 1.25x teleconverter (supplied with this lens), extending its reach to 1000 mm.

*Based on CIPA Standard. This value is achieved when attached to an FX-format digital SLR camera, with zoom set at the maximum telephoto position.

Accessories/System chart/Nomenclature

Wireless Remote Controllers (optional)

Utilizing the 2.4-GHz radio frequency band, the WR-1 and WR-R10/WR-T10 Wireless Remote Controllers enable remote control over long distances. The WR-1 unit also expands your possible shooting scenarios with multiple remote shooting options. You can communicate between WR-1 units separated up to 120 m/394 ft*. Fifteen channels are available. Attaching WR-1 units on several cameras, try simultaneous shutter release, or release their shutters synchronized with a master camera that also has a WR-1 attached. You can also remotely control each group of cameras separately, or try interval timer photography.



WR-1

*Approximate range at height of about 1.2 m/4 ft; varies with weather conditions and presence or absence of obstacles.

GP-1A GPS Unit (optional)

With the optional GP-1A GPS Unit, you can store image information such as latitude, longitude, altitude and UTC (Universal Coordinated Time) as Exif data on any D4S image. Such images can be displayed on the GeoTag workspace of ViewNX 2 (supplied), and this information can also be used on Nikon's image-sharing and storage service NIKON IMAGE SPACE, as well as other online image-sharing services or digital mapping software on the market.



Nikon Professional Services: Keeping professionals shooting

Nikon Professional Services (NPS) assists photographers who earn their living using Nikon equipment. With specialized, individual care, NPS pays attention to each professional photographer's specific set of needs in order to provide real solutions for any technical or logistic issue they face. Whether you need repairs, equipment maintenance or image sensor cleaning, NPS is there. If the repairs take time and an assignment looms, NPS is ready with loan equipment to keep you shooting and meet your deadline. Big sporting and cultural events often serve up make-or-break moments for professionals. That's why the Nikon service depot is present at major events across the globe to ensure that Nikon photographers have what they need to win. Nikon is a true imaging company, so NPS is not only available to still photographers but also to cinematographers and movie productions.

Nomenclature

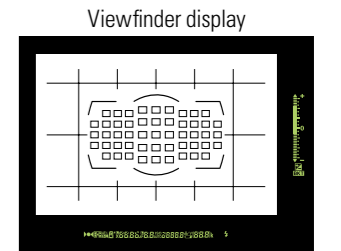
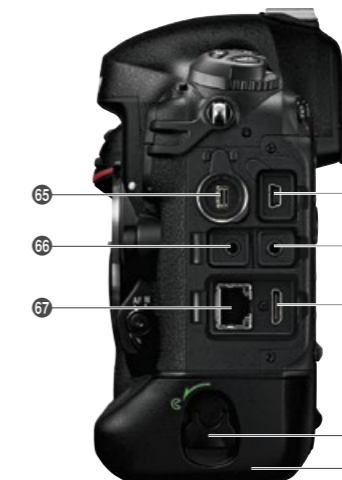
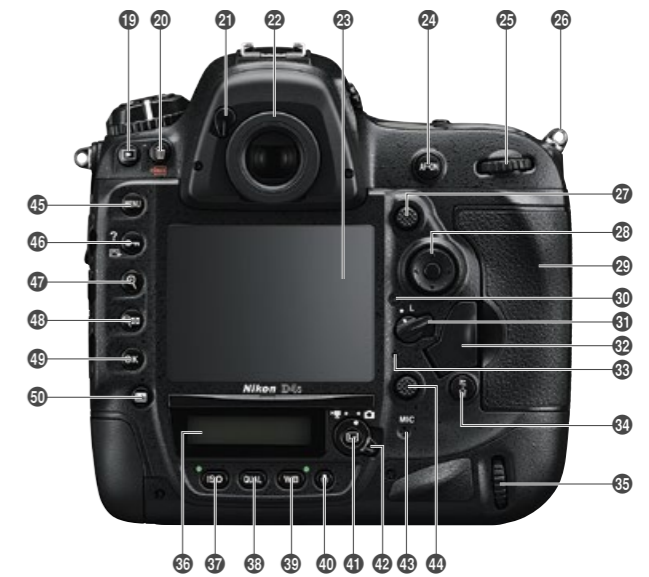

Viewfinder display



Top control panel

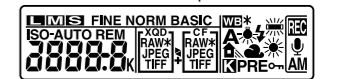

Rear control panel

- 1 Sub-command dial
- 2 Pv button
- 3 Mirror
- 4 Meter coupling lever
- 5 Microphone (for movies)
- 6 Self-timer lamp
- 7 Flash sync terminal (under cover)
- 8 Ten-pin remote terminal (under cover)
- 9 Lens mounting mark
- 10 Lens release button
- 11 AF-mode button
- 12 Focus-mode selector
- 13 Fn button (vertical)
- 14 Shutter-release button for vertical shooting
- 15 Vertical shooting shutter-release button lock
- 16 Sub-command dial for vertical shooting
- 17 Fn button
- 18 Tripod socket
- 19 Playback button
- 20 Deletion button/Formatting memory cards button
- 21 Eyepiece shutter lever
- 22 Viewfinder eyepiece
- 23 Monitor
- 24 AF-ON button
- 25 Main command dial
- 26 Eyelet for camera strap
- 27 Sub-selector
- 28 Multi selector
- 29 Memory card slot cover
- 30 Ambient brightness sensor for automatic monitor brightness control
- 31 Focus selector lock
- 32 Card slot cover release button (under cover)
- 33 Memory card access lamp
- 34 AF-ON button for vertical shooting
- 35 Main command dial (vertical)/Speaker
- 36 Rear control panel
- 37 ISO sensitivity button/Auto ISO sensitivity control button/Two-button reset button
- 38 Image quality button/Image size button
- 39 White balance button/Two-button reset button
- 40 Microphone button
- 41 Live view button
- 42 Live view selector
- 43 Microphone (for voice memos)
- 44 Multi selector (vertical)
- 45 Menu button
- 46 Protection button/Picture Control button/Help button
- 47 Playback zoom in button
- 48 Thumbnail button/Playback zoom out button
- 49 OK button
- 50 Info button
- 51 Release mode dial lock release
- 52 Bracketing button
- 53 Exposure mode button/Formatting memory cards button
- 54 Movie-record button
- 55 Power switch
- 56 Shutter-release button
- 57 Exposure compensation button
- 58 Flash mode button/Flash compensation button
- 59 Metering button
- 60 Release mode dial
- 61 Accessory shoe (for optional flash unit)
- 62 Focal plane mark
- 63 Diopter adjustment control
- 64 Top control panel
- 65 Peripheral connector
- 66 Headphone connector
- 67 Ethernet connector
- 68 USB connector
- 69 Connector for external microphone
- 70 Type C HDMI connector
- 71 Battery-chamber cover latch
- 72 Battery chamber (under cover)

System chart

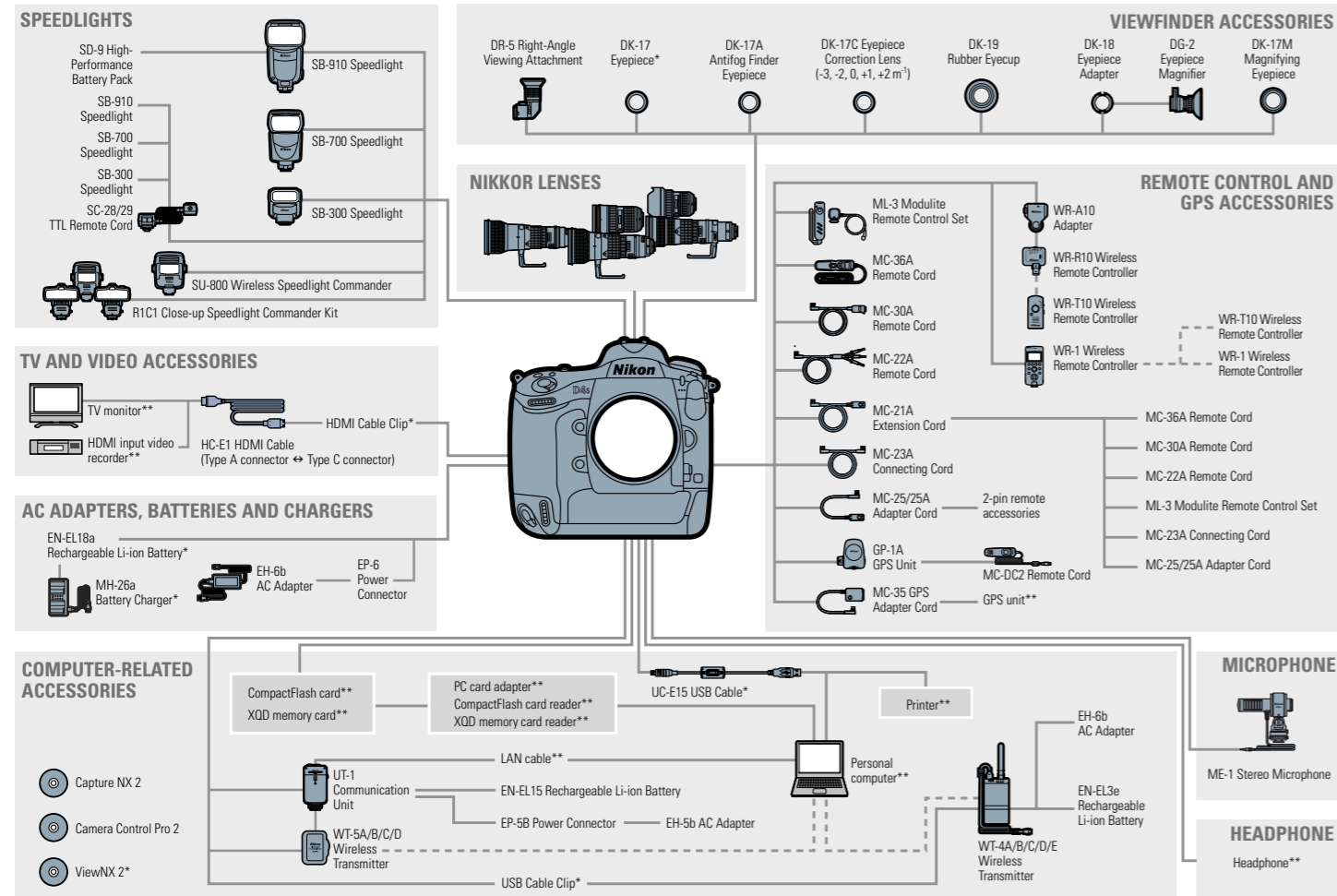

*Supplied accessories **Non-Nikon products

Nikon Digital SLR Camera D4S Specifications

Type of camera	Single-lens reflex digital camera
Lens mount	Nikon F mount (with AF coupling and AF contacts)
Effective angle of view	Nikon FX format
Effective pixels	16.2 million
Image sensor	36.0 × 23.9 mm CMOS sensor
Total pixels	16.6 million
Dust-reduction system	Image sensor cleaning, Image Dust Off reference data (requires optional Capture NX 2 software)
Image size (pixels)	<ul style="list-style-type: none"> FX format (36×24): 4928 × 3280 (L), 3696 × 2456 (M), 2464 × 1640 (S) • 1.2× (30×20): 4096 × 2720 (L), 3072 × 2040 (M), 2048 × 1360 (S) • DX format (24×16): 3200 × 2128 (L), 2400 × 1592 (M), 1600 × 1064 (S) • 5:4 (30×24): 4096 × 3280 (L), 3072 × 2456 (M), 2048 × 1640 (S) • FX-format photographs taken in movie live view (16:9): 4928 × 2768 (L), 3696 × 2072 (M), 2464 × 1384 (S) • DX-format photographs taken in movie live view (16:9): 3200 × 1792 (L), 2400 × 1344 (M), 1600 × 896 (S) • FX-format photographs taken in movie live view (3:2): 4928 × 3280 (L), 3696 × 2456 (M), 2464 × 1640 (S) • DX-format photographs taken in movie live view (3:2): 3200 × 2128 (L), 2400 × 1592 (M), 1600 × 1064 (S) A DX-based format is used for photographs taken using the DX (24×16) 1.5× image area; an FX-based format is used for all other photographs
File format	<ul style="list-style-type: none"> NEF (RAW): 12 or 14 bit, lossless compressed, compressed or uncompressed; small size available (12-bit uncompressed only) • TIFF (RGB) • JPEG: JPEG-Baseline compliant with fine (approx. 1:4), normal (approx. 1:8) or basic (approx. 1:16) compression (Size priority); Optimal quality compression available • NEF (RAW)+JPEG: Single photograph recorded in both NEF (RAW) and JPEG formats
Picture Control System	Standard, Neutral, Vivid, Monochrome, Portrait, Landscape; selected Picture Control can be modified; storage for custom Picture Controls
Storage media	XQD and Type I CompactFlash memory cards (UDMA compliant)
Dual card slots	Either card can be used for primary or backup storage or for separate storage of NEF (RAW) and JPEG images; pictures can be copied between cards
File system	DCF 2.0, DPOF, Exif 2.3, PictBridge
Viewfinder	Eye-level pentaprism single-lens reflex viewfinder
Frame coverage	<ul style="list-style-type: none"> FX (36×24): Approx. 100% horizontal and 100% vertical • 1.2× (30×20): Approx. 97% horizontal and 97% vertical • DX (24×16): Approx. 97% horizontal and 97% vertical 5:4 (30×24): Approx. 97% horizontal and 100% vertical
Magnification	Approx. 0.7× (50 mm f/1.4 lens at infinity, -1.0 m-1)
Eye point	18 mm (-1.0 m ⁻¹); from center surface of viewfinder eyepiece lens
Diopter adjustment	-3 to +1 m ⁻¹
Focusing screen	Type B BriteView Clear Matte Mark VIII screen with AF area brackets (framing grid can be displayed)
Reflex mirror	Quick return
Depth-of-field preview	Pressing Pv button stops lens aperture down to value selected by user (A and M modes) or by camera (P and S modes)
Lens aperture	Instant return, electronically controlled
Compatible lenses	Compatible with AF NIKKOR lenses, including type G, E, and D lenses (some restrictions apply to PC lenses), DX lenses (using DX 24×16 1.5× image area), AI-P NIKKOR lenses, and non-CPU AI lenses (exposure modes A and M only); IX-NIKKOR lenses, lenses for the F3AF, and non-AI lenses cannot be used: The electronic rangefinder can be used with lenses that have a maximum aperture of f/5.6 or faster (the electronic rangefinder supports the 11 focus points with lenses that have a maximum aperture of f/8 or faster)
Shutter type	Electronically controlled vertical-travel focal-plane shutter
Shutter speed	1/8000 to 30 s in steps of 1/3, 1/2 or 1 EV, bulb, time, X250
Flash sync speed	X=1/250 s; synchronizes with shutter at 1/250 s or slower
Release modes	S (single frame), CL (continuous low speed), CH (continuous high speed), Q (quiet shutter-release), S (self-timer), MUP (mirror up)
Frame advance rate	Up to approx. 10 fps (CL) or approx. 10 to 11 fps (CH)
Self-timer	2 s, 5 s, 10 s, 20 s; 1 to 9 exposures at intervals of 0.5, 1, 2 or 3 s
Exposure metering	TTL exposure metering using RGB sensor with approx. 91K (91000) pixels
Metering method	<ul style="list-style-type: none"> Matrix: 3D color matrix metering III (type G, E, and D lenses); color matrix metering III (other CPU lenses); color matrix metering available with non-CPU lenses if user provides lens data Center-weighted: Weight of 75% given to 12-mm circle in center of frame; diameter of circle can be changed to 8, 15 or 20 mm, or weighting can be based on average of entire frame (non-CPU lenses use 12-mm circle) • Spot: Meters 4-mm circle (about 1.5% of frame) centered on selected focus point (on center focus point when non-CPU lens is used)
Metering range	<ul style="list-style-type: none"> Matrix or center-weighted metering: -1 to +20 EV Spot metering: 2 to 20 EV
Exposure meter coupling	Combined CPU and AI
Exposure modes	Programmed auto with flexible program (P); shutter-priority auto (S); aperture-priority auto (A); manual (M)
Exposure compensation	-5 to +5 EV in increments of 1/3, 1/2 or 1 EV
Exposure bracketing	2 to 9 frames in steps of 1/3, 1/2, 2/3 or 1 EV; 2 to 5 frames in steps of 2 or 3 EV
Exposure lock	Luminosity locked at detected value with the center of the sub-selector
ISO sensitivity	ISO 100 to 25600 in steps of 1/3, 1/2 or 1 EV; can also be set to approx. 0.3, 0.5, 0.7 or 1 EV (ISO 50 equivalent) below ISO 100 or to approx. 0.3, 0.5, 0.7, 1, 2, 3 or 4 EV (ISO 409600 equivalent) above ISO 25600; auto ISO sensitivity control available
Active D-Lighting	Can be selected from auto, extra high +2/+1, high, normal, low or off
ADL bracketing	2 frames using selected value for one frame or 3 to 5 frames using preset values for all frames
Autofocus	Nikon Advanced Multi-CAM 3500FX autofocus sensor module with TTL phase detection, fine-tuning, 51 focus points (including 15 cross-type sensors; f/8 supported by 11 sensors)
Detection range	-2 to +19 EV (ISO 100, 20°C/68°F)
Lens servo	<ul style="list-style-type: none"> Autofocus (AF): Single-servo AF (AF-S); continuous-servo AF (AF-C); predictive focus tracking automatically activated according to subject status Manual focus (M): Electronic rangefinder can be used
Focus point	Can be selected from 51 or 11 focus points
AF-area modes	Single-point AF, 9-, 21- or 51-point dynamic-area AF, 3D-tracking, group-area AF, auto-area AF

Focus lock	Focus can be locked by pressing shutter-release button halfway (single-servo AF) or by pressing the center of the sub-selector
Flash control	TTL: i-TTL flash control using RGB sensor with approx. 91K (91000) pixels is available with SB-910, SB-900, SB-800, SB-700, SB-600, SB-400 or SB-300; i-TTL balanced fill-flash for digital SLR is used with matrix and center-weighted metering, standard i-TTL flash for digital SLR with spot metering
Flash modes	Front-curtain sync, slow sync, rear-curtain sync, red-eye reduction, red-eye reduction with slow sync, slow rear-curtain sync, off; auto FP high-speed sync supported
Flash compensation	-3 to +1 EV in increments of 1/3, 1/2 or 1 EV
Flash bracketing	2 to 9 frames in steps of 1/3, 1/2, 2/3 or 1 EV; 2 to 5 frames in steps of 2 or 3 EV
Flash-ready indicator	Lights when optional flash unit is fully charged; flashes after flash is fired at full output
Accessory shoe	ISO 518 hot-shoe with sync and data contacts and safety lock
Nikon Creative	Advanced Wireless Lighting supported with SB-910, SB-900, SB-800 or SB-700 as a master flash; and SB-600 or SB-R200 as remotes, or SU-800 as commander; auto FP high-speed sync and modeling illumination supported with all CLS-compatible flash units except SB-400 and SB-300; Flash Color Information Communication and FV lock supported with all CLS-compatible flash units
Lighting System (CLS)	master flash; and SB-600 or SB-R200 as remotes, or SU-800 as commander; auto FP high-speed sync and modeling illumination supported with all CLS-compatible flash units except SB-400 and SB-300; Flash Color Information Communication and FV lock supported with all CLS-compatible flash units
Sync terminal	ISO 519 sync terminal with locking thread
White balance	Auto (2 types), incandescent, fluorescent (7 types), direct sunlight, flash, cloudy, shade, preset manual (up to 6 values can be stored, Spot White Balance measurement available during live view), choose color temperature (2500 K to 10000 K); all with fine-tuning
White balance bracketing	2 to 9 frames in steps of 1, 2 or 3
Live view modes	Live view photography (quiet or silent), movie live view
Live view lens servo	• Autofocus (AF): Single-servo AF (AF-S); full-time servo AF (AF-F) • Manual focus (M)
AF-area modes	Face-priority AF, wide-area AF, normal-area AF, subject-tracking AF
Autofocus	Contrast-detect AF anywhere in frame (camera selects focus point automatically when face-priority AF or subject-tracking AF is selected)
Movie metering	TTL exposure metering using main image sensor
Frame size (pixels) and frame rate	<ul style="list-style-type: none"> 1920 × 1080; 60p (progressive), 50p, 30p, 25p, 24p • 1920 × 1080 crop; 30p, 25p, 24p and frame rate 1280 × 720; 60p, 50p • 640 × 424; 30p, 25p <p>Actual frame rates for 60p, 50p, 30p, 25p, and 24p are 59.94, 50, 29.97, 25, and 23.976 fps respectively; all options support both ★ high and normal image quality</p>
File format	MOV
Video compression	H.264/MPEG-4 Advanced Video Coding
Audio recording format	Linear PCM
Audio recording device	Built-in monaural or external stereo microphone; sensitivity adjustable
ISO sensitivity	<ul style="list-style-type: none"> Exposure modes P, S and A: Upper limit of Auto ISO sensitivity control is selectable from ISO 400 to Hi 4 Exposure mode M: Auto ISO sensitivity control (ISO 200 to Hi 4) available with selectable upper limit (ISO 400 to Hi 4); manual selection (ISO 200 to 25600 in steps of 1/3, 1/2, or 1 EV) with additional options available equivalent to approximately 0.3, 0.5, 0.7, 1, 2, 3, or 4 EV (ISO 409600 equivalent) above ISO 25600
Maximum length	Approx. 29 min. 59 s (10 or 20 min. depending on frame size/rate and movie quality settings)
Other movie options	Index marking, time-lapse photography
Monitor	8-cm (3.2-in.), approx. 921k-dot (VGA) TFT LCD with 170° viewing angle, approx. 100% frame coverage, manual monitor brightness control, and automatic monitor brightness control using ambient brightness sensor
Playback	Full-frame and thumbnail (4, 9 or 72 images) playback with playback zoom, movie playback, photo and/or movie slide shows, histogram display, highlights, photo information, location data display, auto image rotation, voice memo input and playback, and IPTC information embedding and display
USB	Hi-Speed USB
HDMI output	Type C HDMI connector
Audio input	Stereo mini-pin jack (3.5-mm diameter; plug-in power supported)
Audio output	Stereo mini-pin jack (3.5-mm diameter)
Ten-pin remote terminal	Can be used to connect optional remote control, optional WR-10 (requires WR-A10 Adapter) or WR-1 Wireless Remote Controller, GP-1/GP-1A GPS Unit, or GPS device compliant with NMEA0183 version 2.01 or 3.01 (requires optional MC-35 GPS Adapter Cord and cable with D-sub nine-pin connector)
Ethernet	<ul style="list-style-type: none"> RJ-45 connector • Standards: IEEE 802.3ab (1000BASE-T)/IEEE 802.3u (100BASE-TX)/IEEE 802.3 (10BASE-T) • Data rates: 10/100/1000 Mbps with auto detect (maximum logical data rates according to IEEE standard; actual rates may differ) • Port: 1000BASE-T/100BASE-TX/10BASE-T (AUTO-MDIX)
Peripheral connector	For WT-5A/B/C/D Wireless Transmitter
Supported languages	Arabic, Chinese (Simplified and Traditional), Czech, Danish, Dutch, English, Finnish, French, German, Indonesian, Italian, Japanese, Korean, Norwegian, Polish, Portuguese (Portugal and Brazil), Romanian, Russian, Spanish, Swedish, Thai, Turkish, Ukrainian
Battery	One EN-EL18a Rechargeable Li-ion Battery
AC adapter	EH-6b AC Adapter; requires EP-6 Power Connector (available separately)
Tripod socket	1/4 in. (ISO 1222)
Dimensions (W × H × D)	Approx. 160 × 156.5 × 90.5 mm/6.3 × 6.2 × 3.6 in.
Weight	Approx. 1350 g/2 lb 15.6 oz with battery and XQD memory card but without body cap and accessory shoe cover; approx. 1180 g/2 lb 9.6 oz (camera body only)
Operating environment	Temperature: 0 to 40°C/32 to 104°F; humidity: 85% or less (no condensation)
Supplied accessories	EN-EL18a Rechargeable Li-ion Battery, MH-26a Battery Charger, UC-E15 USB Cable, AN-DC11 Camera Strap, BF-1B Body Cap, BS-2 Accessory Shoe Cover, DK-17 Eyepiece, BL-6 Battery Chamber Cover, UF-2 Connector Cover for Stereo Mini Plug Cable, USB Cable Clip, HDMI Cable Clip, ViewNX 2 CD-ROM

• XQD is a trademark of SONY Corporation. • iPhone® is a trademark of Apple Inc., registered in the U.S. and other countries. • PictBridge is a trademark. • CompactFlash is a registered trademark of SanDisk Corporation. • HDMI, the HDMI logo and High-Definition Multimedia Interface are trademarks or registered trademarks of HDMI Licensing, LLC. • Products and brand names are trademarks or registered trademarks of their respective companies. • Images in viewfinders, on LCDs and monitors shown in this brochure are simulated.



Specifications and equipment are subject to change without any notice or obligation on the part of the manufacturer. May 2014

© 2014 Nikon Corporation

WARNING

TO ENSURE CORRECT USAGE, READ MANUALS CAREFULLY BEFORE USING YOUR EQUIPMENT. SOME DOCUMENTATION IS SUPPLIED ON CD-ROM ONLY.

Visit the Nikon Europe website at: www.europe-nikon.com



Nikon Europe B.V. Tripolis 100, Burgervveeshuispad 101, 1076 ER Amsterdam, The Netherlands
 Nikon U.K. Ltd. Nikon House, 380 Richmond Road, Kingston upon Thames, Surrey KT2 5PR, U.K. www.nikon.co.uk
 NIKON CORPORATION Shin-Yurakucho Bldg., 12-1, Yurakucho 1-chome, Chiyoda-ku, Tokyo 100-8331, Japan www.nikon.com